

# The Design and Development Of Pond Water Quality Control Using pH Booster In Domestication Of Nomei Fish (*Harpodon nehereus*)

Rasmin<sup>1</sup>, Abdul Muis Prasetya<sup>2</sup>, Linda Sartika<sup>3</sup>

[Submission: 27-01-2024, Accepted: 30-06-2024]

**Abstract**— Nomei (*Harpodon nehereus*) is a special fish and one of the characteristic of the city of Tarakan, because it belongs to an endemic animal which is only found in coastal areas which is precisely in Juata laut water. The nutritional and protein content found in nomei fish is very high so it is much favored by the people of Tarakan. Preventing the decline in the population level of nomei fish due to continuous fishing by fisherman so that sustainable and synergistic cultivation is needed by means of domestication. To support nomei fish domestication activities, it is carried out by implementing pond water quality control by considering two measurable parameters, namely water salinity and pH using a microcontroller as a pond water quality controller. The results of controlling the up to down pond water salinity decreased by 3.0316% and the down to up pond water salinity increased in salinity value by 8.18382%. for controlling the pH of pond water, the system worked very well and was able to maintain the pH value at a predetermined set point at 1:08:00 AM, 2:08:00 AM, 3:06:00 AM, 4:33:00 AM, 6:37:00 AM, 7:13:00 AM, and 3:01:00 PM with pH value between 7.5 – 8.5. The recommendation from this study indicated that the water quality control system that had been created was able to maintain and control salinity nomei fish pond according to the given set point value.

**Keywords:** Nomei fish (*Harpodon nehereus*); Domestication; Control; Salinity; pH; Microcontroller.

## I. INTRODUCTION

Tarakan is an island in the North Kalimantan region and has abundant sources of marine products in the fisheries sector, one of the fishery products on Tarakan Island is nomei fish (*Harpodon nehereus*). The nomei fish belongs to the demersal fish which generally live in coastal areas and are originally found in muddy areas, river estuaries, coastal areas, and have body lengths ranging from 40 cm, and generally between 20 - 25 cm [1]. The protein nutrient content of nomei fish is very high, namely 9.6% in wet conditions and 66.5% in dry conditions [2]. Apart from the high economic value, it also has a delicious taste [3], and there are deficiencies in terms of survival, where when fishermen use trawls, these fish are found dead, so many call them soft fish (weak).

---

<sup>1,2,3</sup>Departement of Electrical Engineering University of Borneo Tarakan Jl. Amal Lama No.1 Tarakan, Indonesia (telp: 0853-4535-7535; fax: 0551-2052558; e-mail: [rasminrst@gmail.com](mailto:rasminrst@gmail.com), [prasetya.electric@gmail.com](mailto:prasetya.electric@gmail.com), [lindasartika75@gmail.com](mailto:lindasartika75@gmail.com))

Catching nomei fish by fishermen in their natural habitat which will continuously result in a decreasing population level, the impact of decreasing nomei fish populations will result in reduced income for fishermen [4]. To prevent the decline in the population level of nomei fish, it is necessary to do a way to overcome this problem, namely by proper and synergistic sustainable cultivation, therefore it is necessary to carry out cultivation by means of domestication. Domestication is a process of adaptation or transfer of fish from their natural habitat into a pond that can be controlled. Domestication is carried out with human intervention through stages that are carried out systematically, so that domestication here can also be interpreted as a series of activities of adaptation or adaptation of fish to a new place of residence. [5].

In research [4] regarding the habitat of the nomei fish (*Harpodon nehereus*) in the Juata Sea of Tarakan, it was carried out by measuring water quality parameters and calculating how many catches were in the area so that it was used as a reference to determine that the point could be sampled for water quality parameters. From the results of measuring water quality parameters in the form of measurements of salinity and pH at 7 coordinate points in the coastal area of Juata Laut, at coordinates 03° 26' 54.75" - 117° 36' 07.55" E, as many as 73 individuals with a pH of 8.714 and a salinity of 17 ppm are coordinate point with the most catches. Measurements and sampling were carried out 2 times at each point, and based on the results of sampling and catches of nomei fish by fishermen, it was concluded that at a salinity of 17 ppm and pH 8.714, this is an area of good water quality for the life of nomei fish. Based on the problems above, a study was conducted on the domestication of nomei fish (*Harpodon nehereus*), using a microcontroller as a medium for controlling water quality so that it can produce nomei fish domestication ponds.

## II. SYSTEM DESIGN OR RESEARCH METHODS

### A. Domestication

Domestication is a way for animals to live in controlled conditions so that their original species in the wild become species that can be cultivated and are friendly to humans. The success rate of domestication is caused by two aspects, namely technical and non-technical aspects as well as social and economic factors of the surrounding community. Technically, domestication must pay attention to the location or place where the domestication will be carried out, the technology that will



support the domestication, the facilities that will be used, human resources and business capital. From the biological aspects that need to be considered, namely (growth, food and others). Most aquatic organisms can adapt to different environments so that it is an advantage and can be a support for finding new species or types of fish for domestication activities [6].

### B. Salinity

Salinity is the salt content dissolved in 1 liter of water, expressed in units that generally use 0/00 (per mille, grams per liter). Salinity in the sea is affected by several conditions such as rainfall, flowing rivers, evaporation, and water circulation patterns. In the high seas, the process of changing the level of seawater salinity is very small compared to coastal waters. This can be caused by the large amount of fresh water that enters coastal waters originating from river estuaries, especially during the rainy season [7].

### C. PH (Potential Hydrogen)

The pH of water is the level of acidity which is expressed to measure the degree of acidity of water or alkalinity in a solution. In 1909 the concept of pH was first introduced by a chemist from Denmark, Soren Peder Lauritz Sorensen. The activity algorithm of ions ( $H^+$ ) or pH solutions can be measured experimentally so that the results are based on theoretical calculations that are not included in the absolute scale. The range for measuring acidity starts from 0 to 14 where the pH is 6.5 to 7.5 neutral, above 7.5 is alkaline and below 6.5 is acidic. For a pH value of 0 is the highest degree of acidity and a pH value of 14 is the highest degree of alkalinity [8].

### D. Salinity Sensor

The salinity sensor is a tool that has the function of measuring various types of dissolved solids in units of ppm (mg/l) which are displayed in the form of digital numbers on the display. The method used by the salinity sensor is the Electrical Conductivity method, which uses 2 connected electrodes to obtain the conductance value in the solution to be measured. [9].



Figure 1: Salinity sensor [9].

### E. PH Sensor

The working principle of the pH sensor is to measure the number of electrons in a solution, if the measured electrons have a large number then the solution is acidic and if the number of electrons in the solution is small then the solution is

wet. If the pH value is read  $<7$  then the nature of the solution is acidic and if the pH value is read  $>7$  then the solution is wet. The type of electrode on the pH sensor is a glass electrode so it is sensitive at the tip. In the process of reading the pH value on the pH sensor, it is obtained through a special electrode that is interconnected with an electronic circuit that functions to read and measure the pH value based on the reaction [9].



Figure 2: pH sensor [9].

### F. Microcontroller

Microcontroller is a digital electronic device that has input and output as well as control using a programming language. The microcontroller is also a chip in the form of an IC (Integrated Circuit) which receives the input signal and then processes it into an output signal according to the program entered. The input signal from the microcontroller is obtained from the sensor in the form of a message or information from the surrounding environment, while the output signal is in the form of an actuator which has an impact on the environment [10].

Arduino is in the form of an electric board in which there is a microcontroller module in the form of an IC chip equipped with pins to make it easy to remember. Arduino is also a platform that comes from physical computing which has open source properties. Arduino consists of various kinds of megaAVR microcontrollers, including Atmega8, Atmega 2560 and Atmega168 by utilizing a 16 MHz Crystal Oscillator [10]. The Arduino type used in this study is Atmega 2560.



Figure 3: Arduino atmega 2560

### G. Linear Regression Method

The linear regression method is a mathematical form of equations by predicting the values of the dependent variables from one or more variables. The person who first introduced the term regression, namely Sir Francis Galton, with his research comparing the height of children with their fathers, thus stating that the height of boys is likely to experience a tendency to decline in the next few generations. There are two

types of variables in the linear regression method, namely the response variable (dependent), which is a variable that can be influenced by other variables and is denoted by the letter ( $y$ ) and the predictor variable (independent), which is a variable that cannot be influenced by other variables or can also be called as an independent variable denoted by the letter ( $x$ ) [11].

To see the relationship between the two variables above can be done by means of simple linear regression analysis. This simple linear regression analysis is generally used for sensor calibration as a comparison with the actual measuring instrument value before it is used to collect data for a measurement. Linear regression analysis on sensor calibration is by way of glinearizing the sensor reading value so that it produces the same value as the measuring instrument reading value. The formula of linear regression analysis is as follows.

$$y = bx + c \quad (1)$$

With  $y$  being the factor variable and  $x$  being the response variable,  $b$  and  $c$  can be found using the equation.

$$b = \frac{n(\sum xy) - (\sum x)(\sum y)}{n(\sum x^2) - (\sum x)^2} \quad (2)$$

$$c = \frac{(\sum y)(\sum x^2) - (\sum x)(\sum xy)}{n(\sum x^2) - (\sum x)^2} \quad (3)$$

To find out whether or not the relationship between  $x$  and  $y$  variables is strong, it is done by means of a simple correlation test using the correlation coefficient equation with the Pearson method.

$$r = \frac{n \sum xy - (\sum x)(\sum y)}{\sqrt{(n \sum x^2 - (\sum x)^2)(n \sum y^2 - (\sum y)^2)}} \quad (4)$$

To find out the magnitude of the error from reading the sensor value in percent, it is done using the equation.

$$\text{Error (\%)} = \frac{\text{Gauga Value} - \text{Sensor Reading Value}}{\text{Gauge Value}} \times 100 \quad (5)$$

And to calculate the level of accuracy of the sensor can use the equation.

$$\text{Accuracy} = 100 \% - \text{Error (\%)} \quad (6)$$

### H. Tool Design

The following is a diagram and design of a pool water quality control device using a pH booster for nomei fish domestication (Harpodon nehereus).

#### 1) Control System Blok Diagram

The control system block diagram can be seen in Figure 4.

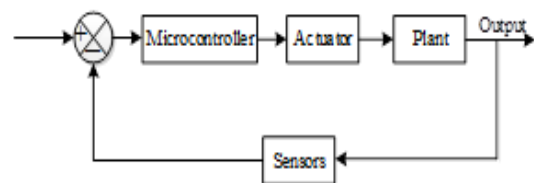

Figure 4: Control system block diagram

Figure 4. is a block diagram of a pond water quality control design and construction system using a pH booster on nomei fish (Harpodon nehereus) domestication. The following is an explanation of the block diagram used.

- The set point is the desired value of the water quality of the nomei fish pond.
- Microcontroller is a means of controlling the entire system.
- The actuator is a driving device that contains a pump, relay, and solenoid.
- The plant is something that will be controlled in the form of a domestication pond of nomei fish.
- Output is the output of the control results in the form of pool water quality.
- The sensor is a tool used to read the quality of pond water.
- Error is the difference between the set point value and the output value.

#### 2) Electric Circuit Block Diagram

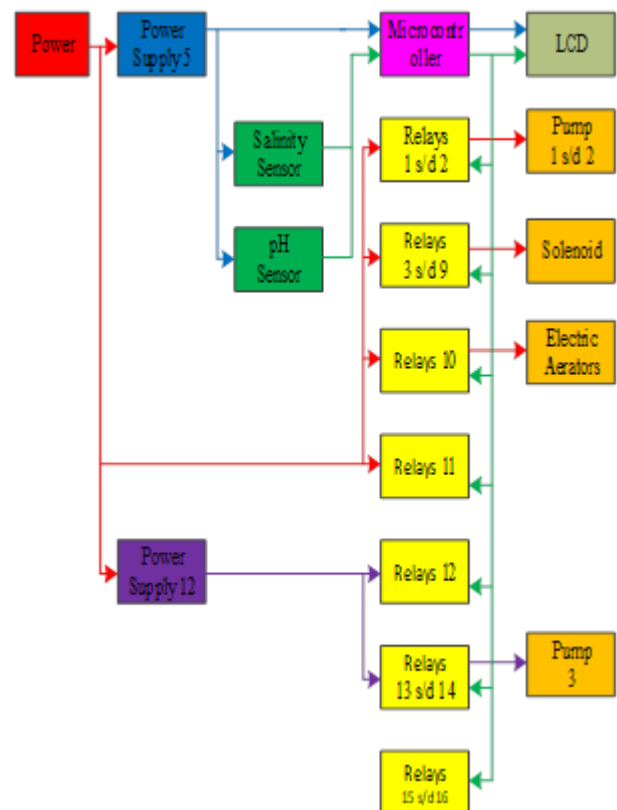

Figure 5: Electric circuit block diagram.



The workings of the electric circuit block diagram Figure 5. namely, the salinity and pH sensors will send digital signal information obtained from pond water quality readings to the microcontroller. Information obtained from the sensor will be processed by the microcontroller, and if the reading value from the sensor does not match the given set point value, the microcontroller will send information in the form of a digital signal to the relay to activate the pump and solenoid to flow the solution into the pond. The electric aerator will remain active which aims to create air bubbles in the pool water.

### 3) Mechanic Circuit Block Diagram

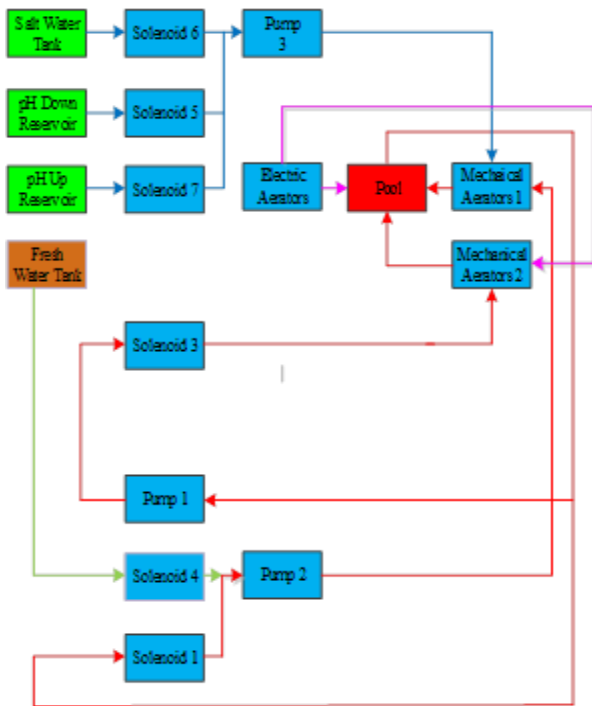

Figure 6: Mechanic circuit block diagram

The workings of the mechanic circuit block diagram are as follows.

- If the pool water is in normal condition then pump 1, pump 2, solenoid 1 and solenoid 3 will continue to be ON to circulate salt water so that it returns to the pond and other components are in OFF condition.
- If the pool water has a low level of salinity below the set point value, pump 3 and solenoid 6 will turn ON to add salt solution to the pond.
- If the pool water has a high salinity level above the set point value, the solenoid will turn ON to add fresh water to the pool.
- If the pool water has a low pH level below the set point value, pump 3 and solenoid 7 will turn ON to add pH Up to the pond.
- If the pool water has a high pH level above the set point value, pump 3 and solenoid 5 will turn ON to add pH Down to the pond.
- The electric aerator will remain ON to circulate air into the pool.

## III. RESULTS AND DISCUSSION

Design and assembly of nomei fish pond water quality control devices consisting of a power supply, arduino, salinity sensor, pH sensor, relay and LCD. After all the components have been prepared, then the process of assembling each component is carried out so that it becomes a means of controlling the quality of pond water. For power supply, microcontroller, relay, main power button and LCD are stored in a panel which serves to reduce interference from getting wet with water or errors occurring due to wiring that is not tight enough. Following is a picture of the pool water quality control circuit.



Figure 7: Pool Water Quality Control Circuit in Panel.

Caption Figure 7:

- Power supply
- Relay
- Microcontroller
- LCD
- Main power button

The salinity and pH sensors will be in the pool to do this reading the pool water, then the data obtained will be sent to Arduino. The other components are assembled to form one Nomei fish domestication ponds whose water quality can be controlled consist of from fish ponds, fresh water profiles, container boxes (salt solutions, pH up solutions and pH down solution). In the process of designing and assembling this tool is very important so that components can carry out their functions as expected.



Figure 8: Design and construction of water quality control equipment for domesticated ponds Nomei fish (*Harpodon nehereus*).

Caption Figure 8:

- a. nomei fish domestication pool
- b. fresh water profile
- c. nomei fish pond water quality control system panel
- d. box container for pH Down solution
- e. box container for pH Up solution
- f. box container for salt solution
- g. pH sensor
- h. Salinity sensor

After the design and assembly process of each component has been completed If this is done, the next step is the process of testing the salinity and pH sensors as well as calibration of the two sensors.

#### A. Salinity Sensor Testing

Sensor testing is carried out to find out whether the salinity sensor reading is in accordance with what is desired, namely being able to read the dissolved salt content in pool water to match the ultimate goal of the research. Before using the salinity sensor, it is necessary to calibrate it first using the simple linear regression method. This method looks at the extent of the causal relationship between the response variable (sensor readings) and the predictor variable (salinity value). Thus, before comparing the sensor reading value with a comparison measuring instrument, the regression method is tested first.

TABLE I  
 CALIBRATION DATA OF SALINITY SENSORS AND REFRACTOMETER MEASUREMENTS

Variable x (salinity)	Variable y (ADC sensor)	x <sup>2</sup>	y <sup>2</sup>	xy
10	679.1	100	461176.8	6791
20	694.5	400	482330.3	13890
28	703.3	784	494630.9	19692.4
38	710.3	1444	504526.1	26991.4
52	720	2704	518400	37440
66	725.3	4356	526060.1	47869.8
75	728.8	5625	531149.4	54660
87	733.7	7569	538315.7	63831.9
Σx = 376	Σy = 5695	Σx <sup>2</sup> = 22982	Σy <sup>2</sup> = 4056589	Σxy = 271166.5

From the calculation results above with an r value of 0.9686 it can be concluded that the two variables have a close or strong relationship. The following is a picture of the correlation scatter diagram between the response variable (sensor readings) and the predictor variable (salinity value).

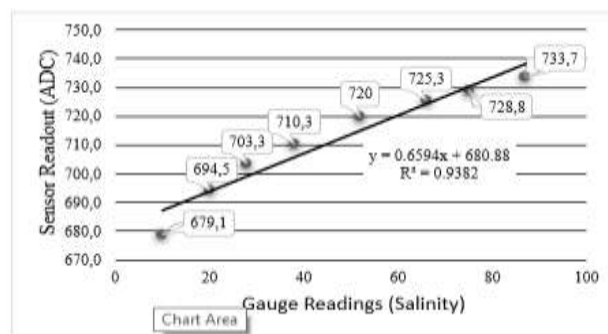

Figure 9: Scatter diagram of correlation of salinity values and ADC sensors

After carrying out linear regression on the sensor, the next step is to test the salinity sensor and the refractor meter as a comparison measure used.

TABLE II  
 SALINITY SENSOR TESTING

Lots of Salt	Gauge Readings	Sensor Reading	Error (%)	Accuracy (%)
1	10	-2.7	127	-27
2	20	20.65	3.25	96.75
3	28	33.99	21.39	78.61
4	38	44.61	17.39	82.61
5	52	59.32	14.07	85.93
6	66	67.35	2.04	97.96
7	75	72.66	3.34	96.66
8	87	80.09	7.94	92.06
Average			24.55	75.44

In Table II after testing the salinity sensor after calibration, it can be seen that the average sensor error is 24.55% and the accuracy is 75.44%. It can be concluded that the salinity sensor used in this study has a fairly good level of accuracy with the caveat that the sensor needs to be calibrated before use and the sensor reading values sometimes deviate greatly or have large error values and the accuracy of the readings is still not accurate enough from the measuring instrument. the comparison.

#### B. pH Sensor Testing

Sensor testing is carried out to find out whether the reading of the pH sensor is as desired, namely being able to read the level of acidity or alkalinity of pool water to match the ultimate goal of the research. Just like the salinity sensor, the pH sensor needs to be calibrated before use using the same method as the salinity sensor, namely simple linear regression. This method looks at the extent of the causal relationship between the response variable (sensor reading) and the predictor variable (pH value). Thus, before comparing the sensor reading value with a comparison measuring instrument, the regression method is tested first.





TABLE III  
PH SENSOR CALIBRATION DATA AND PH METER  
MEASUREMENT

Variable x (pH)	Variable y (ADC sensor)	x <sup>2</sup>	y <sup>2</sup>	xy
4	861	16	741321	3444
4.4	846	19.36	715716	3722.4
4.9	835	24.01	697225	4091.5
5.2	824	27.04	678976	4248.8
5.6	813	31.36	660969	4552.8
6.2	798	38.44	636804	4947.6
7.7	760	59.29	577600	5852
8.1	747	65.61	558009	6050.7
Σx= 46.1	Σy= 6484	Σx <sup>2</sup> = 281.11	Σy <sup>2</sup> = 5266620	Σxy= 36945.8

From the calculation results, the correlation coefficient value is -0.99903 so it can be concluded that the two variables have a close or strong relationship. The following is a graphical image of the correlation scatter diagram between the response variable (sensor readings) and the predictor variable (pH value).

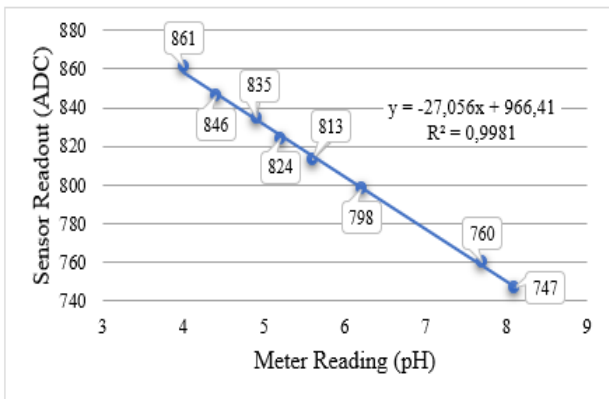

Figure 10: Scatter diagram of the correlation between the pH value and the ADC sensor

After carrying out linear regression on the sensor, the next step is to test the pH sensor and pH meter as a measuring tool used as a comparison and calculate the error and accuracy between the readings of the pH meter and sensor readings so that the average error and accuracy of both can be identified.

TABLE IV  
PH SENSOR TESTING

Multiple pH	Gauge Readings	Sensor Reading	Error (%)	Accuracy (%)
1	4	3.89599223	2.60	97.40
2	4.4	4.450400478	1.15	98.85
3	4.9	4.856966527	0.88	99.12
4	5.2	5.263532576	1.22	98.78
5	5.6	5.670098625	1.25	98.75

6	6.2	6.224506874	0.40	99.60
7	7.7	7.62900777	0.92	99.08
8	8.1	8.109494919	0.12	99.88
Average			1.0675	98.9325

In Table IV testing the pH sensor after calibration it can be seen that the average error is 1.0675%, the highest error value is found at 2.60% and the lowest is 0.12%. The pH sensor used in this study can be concluded that it has a fairly good level of reading accuracy because it has a very small error reading and the average accuracy of the sensor is almost 100%, which is 98.9325%.

C. Pool Water Salinity Test

Testing the salinity of pond water, namely by up to down and down to up which aims to determine changes in salinity with the addition of salt and fresh water solutions over time and pool water volume. The circulation pump will remain on to circulate the pool water.

1) Up to Down Salinity Testing

The up-to-down salinity test is carried out by adding fresh water to the pond.

TABLE V  
SALINITY UP TO DOWN

Time (Minute)	Salinity Value (ppm)	Salinity Reduction (%)	Pool Water Volume (Liters)	Increase in Pool Water Volume (%)
3	17	3.0303	1444.4	4.16667
6	16.5	3.125	1507.2	2.04082
9	16	0	1538.6	2
12	16	3.2258	1570	1.96078
15	15.5	3.3333	1601.4	1.92308
18	15	3.4483	1632.8	1.88679
21	14.5	3.5714	1664.2	1.85185
24	14	3.7037	1695.6	1.81818
27	13.5	3.8462	1727	1.73542
30	13	-	1757.5	-
Salinity reduction average (%)			3.0316	
Average pool water volume (%)			2.15373	

From the results of the up to down salinity test in Table V, it can be seen that by testing for an interval of 3 minutes, the pool water salinity value will decrease gradually with an average decrease of 3.0316% and the volume of water in the pond will tend to decrease. increased, which was caused by the addition of fresh water into the pond with an average increase of 2.15373%.

2) Down to Up Salinity Testing

In the down to up salinity test is done by adding a solution of salt water into the pond.

TABLE VI  
 DOWN TO UP SALINITY

Time (Minute)	Salinity Value (ppm)	Increase in Salinity (%)	Pool Water Volume (Liters)	Increase in Pool Water Volume (%)
3	5	16.6667	785	3.84615
6	6	14.2857	816.4	3.7037
9	7	12.5	847.8	3.57143
12	8	11.1111	879.2	6.66667
15	9	10	942	3.22581
18	10	0	973.4	11.4286
21	10	0	1099	2.77778
24	10	9.09091	1130.4	2.7027
27	11	0	1161.8	5.12821
30	11	-	1224.6	-
Average increase in salinity (%)			8.18382	
Average pool water volume (%)			4.78345	

From the results of the pool water salinity test which was carried out in a down to up manner in Table VI, it can be seen that by testing for an interval of 3 minutes, the pool water salinity value will increase gradually with an average increase of 8.18382% and the volume of water in the pond will tend to increase. increased, which was caused by the addition of salt water solution into the pond with an average increase of 4.78345%. The following is a graph of the salinity test against time and pool water volume.

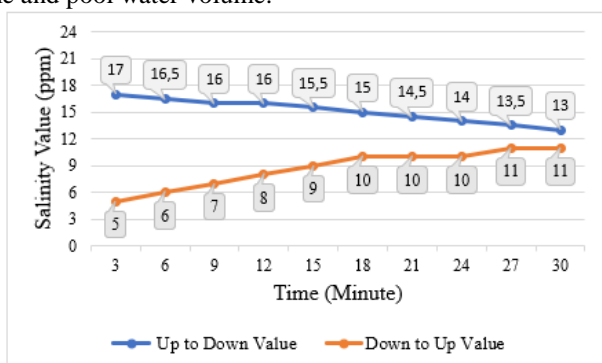

Figure 11: Pool water salinity test graph.

#### D. Pool Water pH Testing

Testing the pH of pond water is the same as testing salinity, namely by up to down and down to up which aims to determine changes in pH when adding a solution of pH up and down in pool water. A mixture of pH up solutions in the form of potassium hydroxide which is commonly used to raise the pH in hydroponic plants. As for the mixture in the pH down solution, use a phosphoric acid solution which is commonly used to lower the pH in hydroponic plants.

##### 1) pH Up to Down pH Testing

The uptodown pH test is carried out by adding a pH down solution into the pond then the sensor will read changes in the pH value that occur over time and the volume of pool water.

Rasmin: The Design and Development ...  
 2372

TABLE VII  
 PH UP TO DOWN

Time (Minute)	pH Value	Decrease in pH (%)	Pool Water Volume (Liters)	Increase in Pool Water Volume (%)
3	4.858	13.611	890.19	2.778
6	4.276	8.6382	915.624	2.702
9	3.936	7.1604	941.058	2.634
12	3.673	17.236	966.492	2.564
15	3.133	4.5728	991.926	2.500
18	2.996	6.3165	1017.36	4.762
21	2.818	5.7014	1068.228	2.325
24	2.666	7.9352	1093.662	2.272
27	2.47	1.479	1119.096	2.222
30	2.434	16.071	1144.53	2.174
33	2.097	2.593	1169.964	2.128
36	2.044	20.947	1195.398	2.083
39	1.69	3.6174	1220.832	2.041
42	1.631	6.6013	1246.266	2.000
45	1.53	-	1271.7	-
Average pH reduction (%)			8.7485	
Average pool water volume (%)			2.51317	

From the results of the up to down pH test in Table VII it can be seen that with an interval of 3 minutes the pH value of the pool water will decrease gradually with an average decrease of 8.7485% and the volume of the pool water will increase with the addition of a pH down solution into the pond with an average increase of 2.51317%.

##### 2) Down to Up pH Testing

In the down to up pH test is done by adding a pH up solution into the pond then the sensor will read changes in the pH value that occur over time and the volume of pool water.

TABLE VIII  
 PH UP TO DOWN

Time (Minute)	pH Value	Increase in pH (%)	Pool Water Volume (Liters)	Increase in Pool Water Volume (%)
3	5.71	7.5004	1297.13	1.9235
6	6.173	8.1945	1322.57	3.7038
9	6.724	2.8604	1373.44	1.8178
12	6.922	5.7333	1398.87	1.7854
15	7.343	4.8217	1424.3	3.4484
18	7.715	3.0047	1475.17	1.6953
21	7.954	2.2850	1500.61	3.2781
24	8.14	2.4097	1551.47	1.6132
27	8.341	1.7086	1576.91	1.5870
30	8.486	1.4058	1602.34	1.5628
33	8.607	0.8866	1627.78	1.5328
36	8.684	1.4525	1653.21	2.9851
39	8.812	0.1133	1704.08	1.4703
42	8.822	1.1208	1729.51	2.8572
45	8.922	-	1780.38	-
Average increase in pH (%)			3.107	
Average pool water volume (%)			2.2333	



From the results of the down to up pH test in Table VIII it can be seen that with an interval of 3 minutes the pH of the pool water will rise gradually with an average increase of 3.107% and the volume of the pool water will increase with the addition of a pH up solution into the pond with an average an increase of 2.2333%. The following is a graph of testing the pH against the time and volume of pool water.

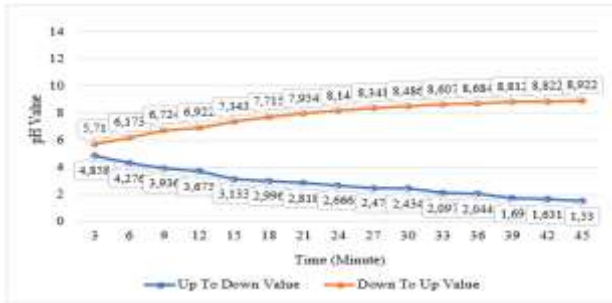

Figure 12: Graph of pool water pH testing

E. Pool Water pH Open Loop Control Test

The open loop test is carried out 1 × 24 hours with the condition that the pool water volume remains constant and the circulation pump will remain on to circulate the pool water with the aim that the water conditions at the bottom and surface of the pool remain the same. The sensor reading value does not only cover one particular point, but this value can represent the entire pool water with the help of a circulation pump. The open loop control test aims to observe changes in the pH of the pool water to the environment and the surrounding temperature, so that it can be seen that the value of the level of change in the pH of the pool water is caused by the surrounding environment both during the day and at night. Table IX The following is a test of the pool water pH open loop control which was carried out 1 × 24 hours.

TABLE IX  
POOL WATER OPEN LOOP CONTROL TESTING

Time (Hour)	pH Value
7:32:18 PM	7.51
8:30:15 PM	7.63
9:30:45 PM	7.46
10:30:37 PM	7.53
11:30:04 PM	7.19
12:30:15 AM	7.02
1:39:20 AM	6.85
2:30:40 AM	6.75
3:31:14 AM	6.57
4:30:34 AM	6.81
5:54:58 AM	6.37
6:31:24 AM	6.65
7:30:09 AM	6.66
8:30:17 AM	6.68
9:32:19 AM	6.88
10:43:36 AM	6.97
11:47:32 AM	6.61
12:30:28 PM	6.55
1:30:37 PM	6.24

2:30:10 PM	6.15
3:31:49 PM	6.1
4:32:24 PM	5.96
5:30:25 PM	5.77
6:30:11 PM	5.7
7:30:07 PM	5.53

From the data from the test results in Table IX open loop pH of pool water, it can be seen that with an interval of 1 hour, data collection will decrease. At 7:32:18 PM – 12:30:15 AM the pool water is still in the pH range of 7, and at 01:39:20 AM – 3:31:49 PM the pH of the pool water has decreased and is at pH 6 and at 4:32:24 PM – 7:30:07 PM the pH value of pool water will decrease and has reached a pH value range of 5. Based on the open loop testing of pool water pH, it can be concluded that changes in pool water pH are caused by the length of time the water is in the pond and surrounding environmental factors that cause an increase or decrease in the pH value of pond water. The following is an open loop control chart for pond water pH which was carried out within 1 × 24 hours of data collection.

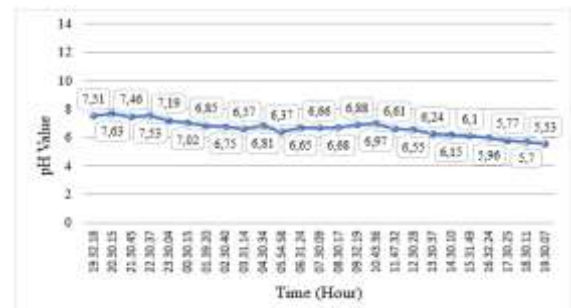

Figure 13. Graph of pool water pH open loop testing

F. Testing of the Overall Close Loop Control System for Pool Water pH

Close loop testing is carried out with the same mechanism as open loop where the test is carried out 1 × 24 hours with the condition that the circulation pump will remain on to circulate the pool water with the aim that the water conditions at the bottom and surface of the pool remain the same. In the close loop control test there is feedback from the reading of the microcontroller sensor so it is necessary to give a set point value of 8 based on the results of nomei fish spawning research (Nugroho et al., 2017) for pH values with a range in the range of 7.5 – 8.5 stated under normal conditions and if outside of the range is stated in abnormal conditions.

If the reading of the sensor value does not match the given set point, the microcontroller will process the data for controlling the pH of the pool water by adding a pH up and down pH solution so that it is expected that the pH value of the pool water will be the same as the given set point value. The volume of pond water will increase along with the addition of pH up and down pH solutions into the pond. Close loop testing aims to observe whether the system that has been made is able to maintain the condition of pond water quality with a given set point value.



TABLE X  
 TESTING OF THE ENTIRE CLOSE LOOP CONTROL SYSTEM OF  
 POOL WATER PH

Time (Hour)	pH value	Pool Water Volume (Liter)	Condition
1:08:00 AM	7.89	1475.17	Normal
2:08:00 AM	7.77	1500.61	Normal
3:06:00 AM	7.78	1551.47	Normal
4:33:00 AM	7.85	1576.91	Normal
5:10:00 AM	7.28	1602.34	Abnormal
6:37:00 AM	7.63	1627.78	Normal
7:13:00 AM	8.02	1653.21	Normal
8:02:00 AM	7.12	1704.08	Abnormal
9:00:00 AM	6.45	1729.51	Abnormal
10:00:00 AM	7.29	1780.38	Abnormal
11:00:00 AM	7.49	1831.25	Abnormal
12:00:00 PM	7.47	1856.68	Abnormal
1:01:00 PM	7.3	1882.12	Abnormal
2:05:00 PM	7.3	1932.98	Abnormal
3:01:00 PM	7.75	1958.42	Normal
4:00:00 PM	7.41	1034.72	Abnormal
5:00:00 PM	7.1	1060.15	Abnormal
6:14:24 PM	7.18	2085.59	Abnormal
7:00:00 PM	7.14	2136.46	Abnormal
8:12:00 PM	7.01	2161.89	Abnormal
9:08:00 PM	6.42	2187.32	Abnormal
10:01:00 PM	7.04	2238.19	Abnormal
11:04:00 PM	7.24	2263.63	Abnormal
12:17:00 AM	7.2	2314.49	Abnormal
1:03:00 AM	7.41	2339.93	Abnormal

From the test results data Table X close loop pH of pool water, it can be seen that at 1:08:00 AM, 2:08:00 AM, 3:06:00 AM, 4:33:00 AM, 6:37:00 AM, 7:13:00 AM and 3:01:00 PM The pH of pool water is normal and at 5:10:00 AM, 8:02:00 – 2:05:00 PM and 4:00:00 PM – 1:03:00 AM The pH of pool water is in an abnormal condition or does not match a predetermined set point value. The average condition of the pH of pool water based on Table X is at a pH value of 7, and the inhibiting factor in the close loop test is the volume of water which tends to increase along with the addition of a pH up or down pH solution to the pool water. The following is a close loop control chart for pond water pH which was carried out within 1 × 24 hours.

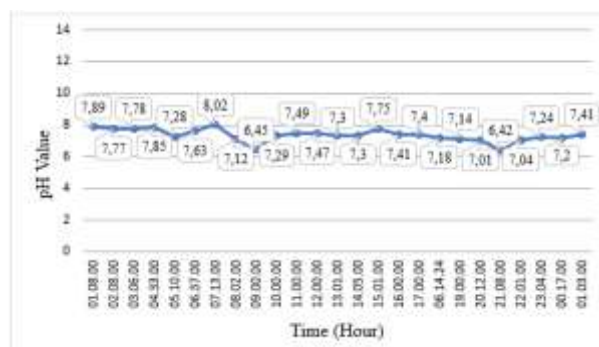

Figure 14: Graph of the overall test of the pool water pH close loop control system

TABLE XI  
 ERROR VALUE OF POOL WATER PH DATA WITH SET POINT VALUES

Time (Hour)	Error (%)
1:08:00 AM	1.375
2:08:00 AM	2.875
3:06:00 AM	2.75
4:33:00 AM	1.875
5:10:00 AM	9
6:37:00 AM	4.625
7:13:00 AM	0.25
8:02:00 AM	11
9:00:00 AM	19.375
10:00:00 AM	8.875
11:00:00 AM	6.375
12:00:00 PM	6.625
1:01:00 PM	8.75
2:05:00 PM	8.75
3:01:00 PM	3.125
4:00:00 PM	7.375
5:00:00 PM	7.5
6:14:24 PM	10.25
7:00:00 PM	10.75
8:12:00 PM	12.375
9:08:00 PM	19.75
10:01:00 PM	12
11:04:00 PM	9.5
12:17:00 AM	10
1:03:00 AM	7.375
Average Error	8.1

In Table XI the error value between the pool water pH data and the set point can be seen that the average error between the set point value and the pool water pH data is 8.1%, the highest error value is 19.75% and the lowest is 0.25%. in the close loop test the pool water pH has a large percentage error due to the length of time the water has been in the pond which causes the pH value to tend to decrease. The following is a graph of the error value of pool water pH data with set points carried out for 1 × 24 hours of data collection.



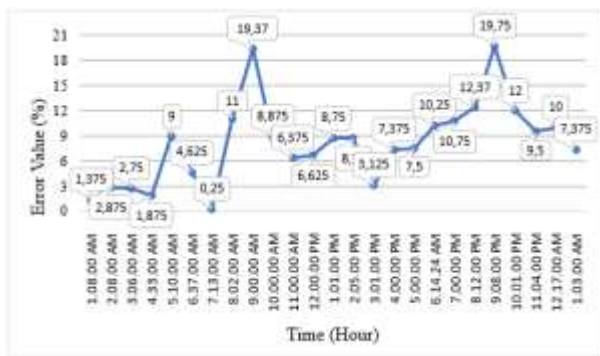

Figure 15: Graph of the error value of pool water pH data with a set point

#### IV. CONCLUSION

Based on the results of research on the design and construction of pond water quality control using a pH booster on nomei fish (*Harpodon nehereus*) distification that has been carried out, several conclusions can be drawn as follows.

- 1) The results of controlling the up to down pond water salinity decreased by 3.0316% and down to up the increase in salinity value was 8.18382%. For controlling the up to down pH of pool water, it decreased by 8.7485% and during down to up the pH value increased by 3.107%.
- 2) The results of testing the pool water pH with an open loop, the data obtained for 1 × 24 hours is at 7:32:18 PM – 12:30:15 AM is in the pH range 7, at 01:39:20 AM – 3:31:49 PM is in the pH range of 6 and at 4:32:24 PM – 7:30:07 PM the pH of the water is in the range of 5.
- 3) The results of testing the entire system with a closed loop, the data obtained from the control results so that the pH of the pool water remains stable at the predetermined set point at 1:08:00 AM, 2:08:00 AM, 3: 06:00 AM, 4:33:00 AM, 6:37:00 AM, 7:13:00 AM and 3:01:00 PM. The average error of pool water pH data with a set point value is 8.1%, an error value of 19.75% and for the lowest error value is 0.25%.
- 4) Recommendations from the results of research conducted by collecting data for 1 × 24 hours on testing the entire system on close loop control of pool water pH shows that the water quality control system that has been created is able

to maintain and control the pH of nomei fish pond water according to the set point value set given.

#### ACKNOWLEDGMENT

This research was fully supported by a discussion group that participated in the design of a pond water quality control system using a pH booster on nomei fish (*Harpodon nehereus*) domestication in Electrical Engineering at the Faculty of Engineering, University of Borneo Tarakan.

#### BIBLIOGRAPHY

- [1] M. Firdaus, G. Salim, E. Maradhy, I. R. Abdiani and Suryono, "Analysis of Growth and Age Structure of Nomei Fish (*Harpodon nehereus*) in Juata Waters, Tarakan City," *Journal Akuatika*, Vol. IV, No.2 : 160, 2013.
- [2] M. Firdaus, J. Cahyadi, and G. Salim, "Analysis of Protein Tests by Comparing Fishermen's Catches and Processing Results of Nomei Fish (*Harpodon nehereus*) in Tarakan City," *Seminar UNIBRAW: Tarakan Borneo University*, 2012.
- [3] G. Salim, Rukisah, Azis, M. Firdaus, T. Toha, Awaluddin, A. M. Prasetya, C. D. Nugraeni, M. F. A. Hafizh, Rahmatsyah, H. Ipa, V. Muslikah, R. Safira, S. S. Satri, T. S. Jati, A. Jahil, M. A. Fauzi, LailatulRif'ah, and E. Wulandari, "Processing of Nomei Fish (*Harpodon nehereus*) into Nuggets in the Juata Laut Area of Tarakan City," *Journal of Community Service*, Vol. 1, No.3 : 127, 2022.
- [4] E. D. Nugroho, Vlorensius, and A. Salurapa, "Spawning Preferences and Habitat for Nomei Fish (*Harpodon nehereus*) in Juata Laut Tarakan Waters as a Conservation Effort," *Journal Biogenesis*, Vol. 5, No.1 : 55-59, 2017.
- [5] S. Muhlis, Hendrianto, S. Purba, A. Darmono and Kurniawan, "Domestication of Lobo Snapper (*Lobotes surinamensis*) from Batam Waters and Its Growth in Floating Net Cage," *Journal SIMBIOISA*, Vol. 7, No.2 : 136, 2018.
- [6] Y. Kuniyo, and Juliana, "Domestication of Manggabei Fish (*Glossogobius Giuris*) Through Optimization of the Environment and Feed," *Final Year Assignment, Higher Education Excellence Research, State University of Gorontalo*, 2017.
- [7] K. M. Ihwan, "Design of a System for Controlling Temperature, Acidity and Salinity in Grouper Ponds Based on Microcontrollers," *THESIS*, 2019.
- [8] G. A. Saputra, "Analysis of the Workings of the Ph-E4502c Sensor Using the Arduino Uno Microcontroller to Design a Water Ph Control Tool in Ponds," *SCIENTIFIC WRITING*, 2020.
- [9] G. A. Putera and Christiand D. H. F. M, "Design of Measuring Instruments for Dissolved Solids, Turbidity and Water Ph Using Arduino Uno," *FINAL PROJECT*, 2017.
- [10] R. K. Simbolon, "Design of Feeding Automation and Water Ph Setting in Atmega32-Based Shrimp Pond Circulation," *THESIS*, 2020.
- [11] Suyono, "Regression Analysis For Research. Indonesia: Yogyakarta, 2018.